

1B

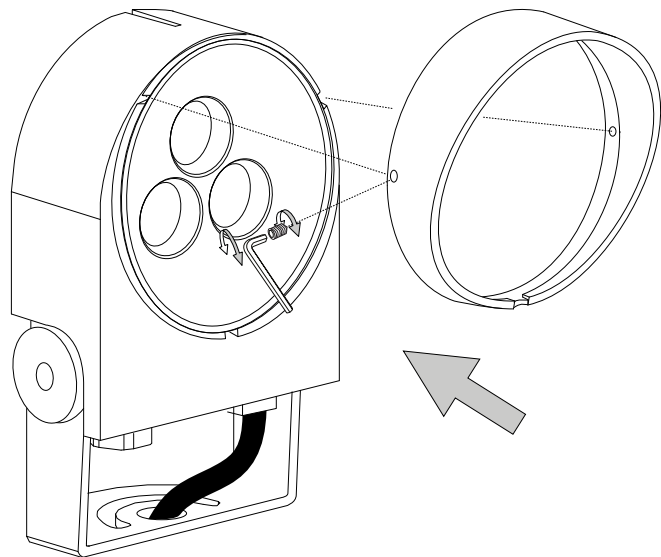

ideal lux®



REV 22/09/2022

Ulex 08W Source

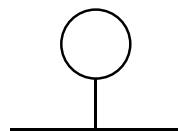

Lampada da terra
 Floor lamp
 Lampadaire
 Stehleuchte
 Lámpara de pie
 Торшеры

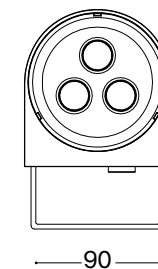

LED

8,5W LED / 220~240V 50/60Hz
 - 8021696261287 ANTRACITE

1C

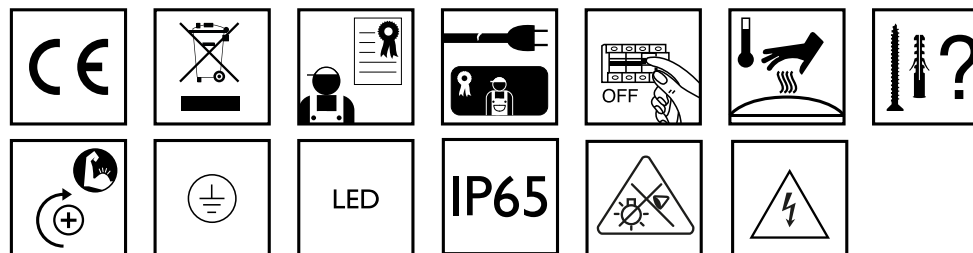
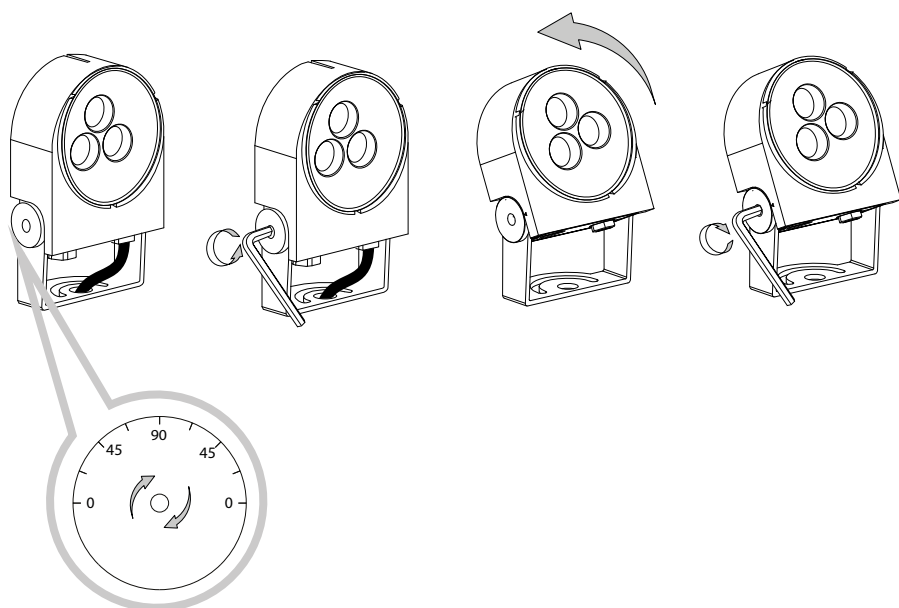

IDEAL LUX s.r.l.
 Via Taglio Destro 32
 30035 Mirano (VE) Italy
 www.ideal-lux.com

IDEAL LUX Warehouse
 Via delle Industrie, 8/D
 30036 Santa Maria di Sala (Venezia)
 8.00 - 12.00 / 13.30 - 17.00

ESEGUIRE LE OPERAZIONI SEGUENDO L'ORDINE PROGRESSIVO.
FOLLOW THE ASSEMBLY INSTRUCTIONS BY READING THE NUMERICAL PROGRESSION.

L'INSTALLAZIONE DI QUESTO APPARECCHIO DEVE ESSERE EFFETTUATA DA PERSONALE
QUALIFICATO. THE LIGHTING FITTING SHOULD BE INSTALLED BY A QUALIFIED ELECTRICIAN.

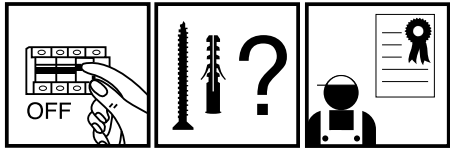

MORSETTIERA E SCATOLA DI DERIVAZIONE NON INCLUSE.
JUNCTION AND TERMINAL BOXES NOT INCLUDED.

1

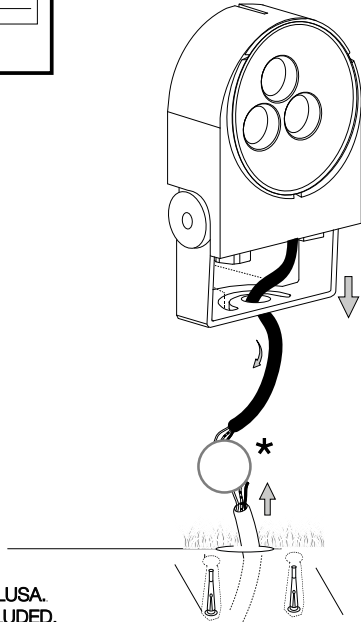

* MORSETTIERA IP68 2 x 1,5 mm². NON INCLUSA.
TERMINAL BOX IP68 2 x 1,5 mm² NOT INCLUDED.

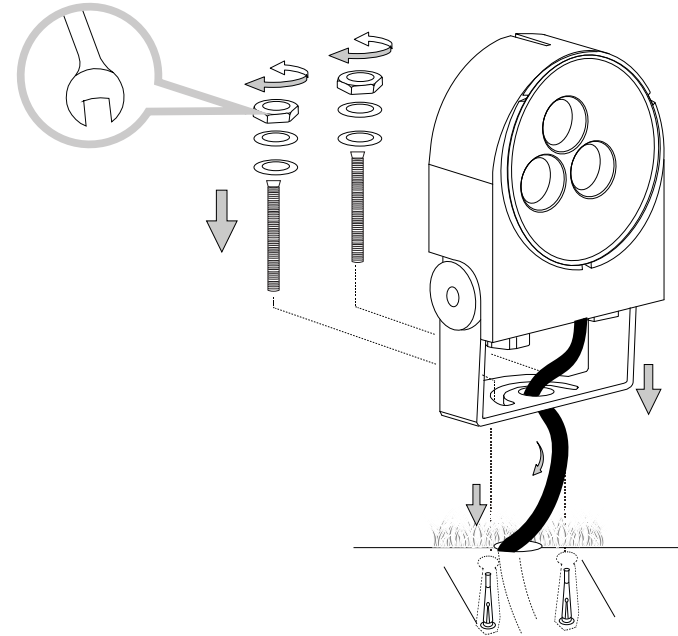

2

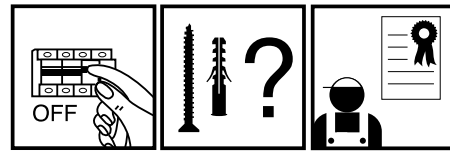

MORSETTIERA E SCATOLA DI DERIVAZIONE NON INCLUSE.
JUNCTION AND TERMINAL BOXES NOT INCLUDED.

1B

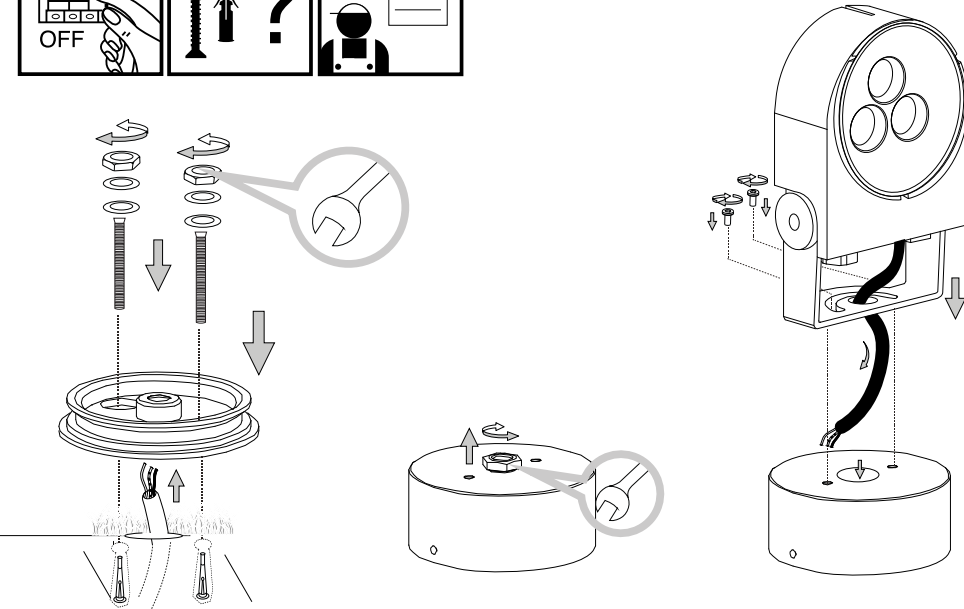

* MORSETTIERA IP68 2 x 1,5 mm². NON INCLUSA.
TERMINAL BOX IP68 2 x 1,5 mm² NOT INCLUDED.

2B

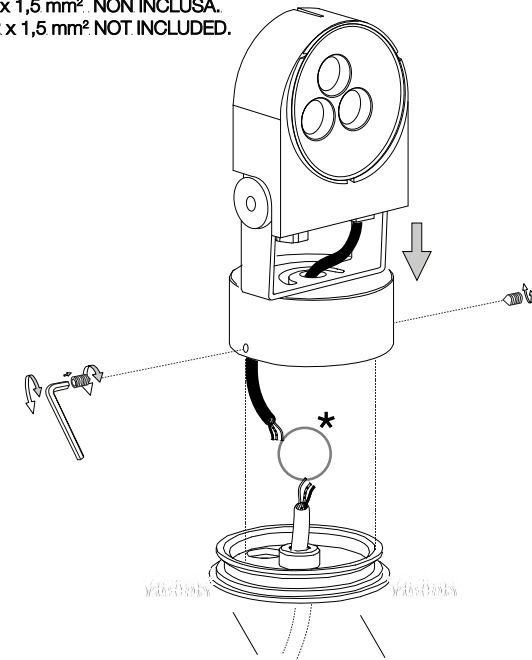

LA SICUREZZA DI QUESTO APPARECCHIO È GARANTITA SOLO CON L'USO APPROPRIATO DI QUESTE ISTRUZIONI, PERTANTO È NECESSARIO CONSERVARLE.
THE SAFETY AND RELIABILITY ARE GUARANTEED ONLY WHEN INSTALLATION INSTRUCTIONS ARE PROPERLY FOLLOWED. PLEASE KEEP THIS INSTRUCTION SHEET FOR FUTURE REFERENCE.

ESEGUIRE LE OPERAZIONI SEGUENDO L'ORDINE PROGRESSIVO.
FOLLOW THE ASSEMBLY INSTRUCTIONS BY READING THE NUMERICAL PROGRESSION.

L'INSTALLAZIONE DI QUESTO APPARECCHIO DEVE ESSERE EFFETTUATA DA PERSONALE
QUALIFICATO. THE LIGHTING FITTING SHOULD BE INSTALLED BY A QUALIFIED ELECTRICIAN.

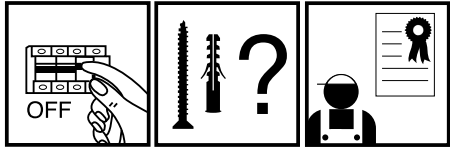

MORSETTIERA E SCATOLA DI DERIVAZIONE NON INCLUSE.
JUNCTION AND TERMINAL BOXES NOT INCLUDED.

1C

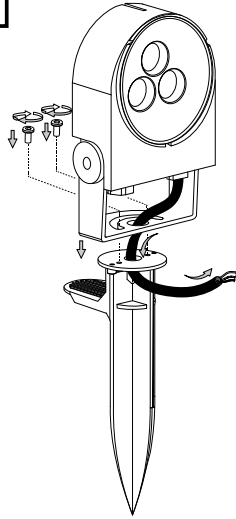

* MORSETTIERA IP68 2 x 1,5 mm². NON INCLUSA.
TERMINAL BOX IP68 2 x 1,5 mm². NOT INCLUDED.

2C

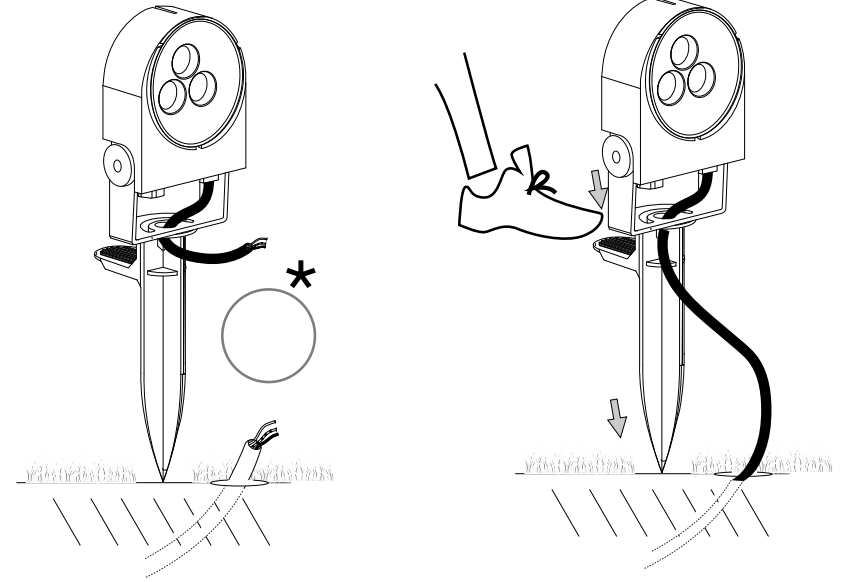

LA SICUREZZA DI QUESTO APPARECCHIO È GARANTITA SOLO CON L'USO APPROPRIATO DI QUESTE ISTRUZIONI, PERTANTO È NECESSARIO CONSERVARLE.
THE SAFETY AND RELIABILITY ARE GUARANTEED ONLY WHEN INSTALLATION INSTRUCTIONS ARE PROPERLY FOLLOWED. PLEASE KEEP THIS INSTRUCTION SHEET FOR FUTURE REFERENCE.

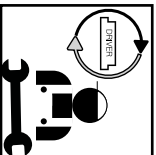
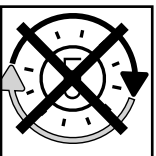

Questo prodotto contiene una sorgente luminosa di classe di efficienza energetica / This product is provided with a light source with efficiency energy class of:

EAN	Modello Sorgente Luminosa /Light Source Model	Classe di Efficienza Energetica / Energy Efficiency Class	Sorgente Luminosa / Light Source (mA)	Sorgente Luminosa / Light Source (V)
8021696261287	ULEX 08W	F	700 mA	9 V DC

LEGENDA ICONE

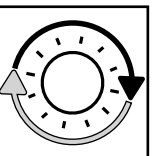

Sorgente luminosa sostituibile dall'utente finale.
Replaceable light source by an end-user.

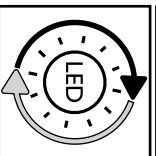

Sorgente LED luminosa sostituibile dall'utente finale.
Replaceable LED light source by an end-user.

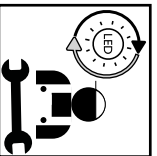

Sorgente luminosa sostituibile esclusivamente da personale autorizzato.
Replaceable light source by authorized personnel only.

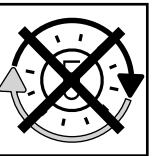

Sorgente luminosa non sostituibile.
Quando la sorgente arriverà a fine vita dovrà essere sostituito l'intero apparecchio.
Non-replaceable light source.
Upon end of life of the light source, the whole product will be replaced.

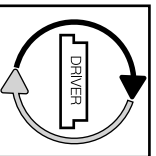

Dispositivo di alimentazione sostituibile dall'utente finale.
Replaceable control gear by an end-user.

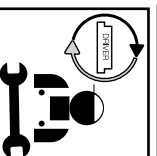

Dispositivo di alimentazione sostituibile esclusivamente da personale autorizzato
Replaceable light source by authorized personnel only.

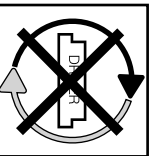

Dispositivo di alimentazione non sostituibile.
Quando il dispositivo di alimentazione arriverà dovrà essere sostituito l'intero apparecchio.
Upon end of life of the control gear, the whole product will be replaced.

- 18.** Jei apsauginis stiklas yra įskilęs arba sudužęs, pakeiskite jį nedelsiant ir naudodami tik nuostatus atitinkančias keičiamas dalis.
- 19.** Šviesos šaltinis su nekeičiamais šviesos diodais (LED). Neišmontuokite gaminio, nes diodai gali pažeisti akis. Nejmerkite į vandenį. Valykite naudodami drėgną šluostę ir venkite stiprių tirpiklių ir ploviklių naudojimo.
- 20.** Prietaise įdiegtas lydysis saugiklis. Jei šviestuvą neįsijungia, pakeiskite lydųj saugiklį.
- 21.** I-ą elektros saugos klasę užtikrina bendra izoliacija bei apsauginis laidininkas (žeminimas) prijungtas prie metalinės šviestuvo dalies. Privalomas žeminimas
- 22.** II-ą elektros saugos klasę užtikrina bendra izoliacija ir dviguba izoliacija arba sustiprinta izoliacija. Žeminimas nėra būtinas.
- 23.** III-ą elektros saugos klasę užtikrina labai žemos įtampos maitinimas (mažesnis, nei 50 voltų). Žeminimas nėra būtinas.
- 24.** Neapsaugotas.
- 25.** Apsaugotas nuo kietųjų kūnų, kurių skersmuo didesnis, nei 50 mm. patekimo.
- 26.** Apsaugotas nuo kietųjų kūnų, kurių skersmuo didesnis, nei 12 mm. patekimo.
- 27.** Apsaugotas nuo kietųjų kūnų, kurių skersmuo didesnis, nei 2,5 mm. patekimo.
- 28.** Apsaugotas nuo kietųjų kūnų, kurių skersmuo didesnis, nei 1 mm. patekimo.
- 29.** Apsaugotas nuo dulkių patekimo.
- 30.** Visiškai apsaugotas nuo dulkių patekimo.
- 31.** Neapsaugotas.
- 32.** Apsaugotas nuo statmenai krentančių vandens lašų patekimo.
- 33.** Apsaugotas nuo vandens lašų, kurių kritimo didžiausias kampas yra 15°, patekimo.
- 34.** Apsaugotas nuo lietaus.
- 35.** Apsaugotas nuo vandens pusrų.
- 36.** Apsaugotas nuo vandens čiurkšnių.
- 37.** Apsaugotas nuo stiprių vandens čiurkšnių.
- 38.** Apsaugotas nuo laikino įmerkimo.
- 39.** Apsaugotas nuo įmerkimo tam tikram laikui.
- 40.** Prietaisas neturi būti uždengiamas šilumą izoliuojančia medžiaga.
- 41.** Dėmesio, elektros smūgio pavojus.
- 42.** Nežiūrėkite tiesiai į šviesos šaltinį.