

General info

Technical - Accessories

Indoor dimmable constant current driver



Ean	8021696266671
Item	OFF DRIVER 1-10V/PUSH 32W 700mA
Installation	Driver
Guarantee	5 years
Gross weight	0.19 kg
Volume	0.000184 m ³

Technical info

Net weight	0.12 kg
Insulation class	II
Protection index	IP20
Compliance	CE
Operating temperature	0° ~ +40 °C
Full load efficiency	0,88
Dimmer	Dimmable, 1-10V / Push
Accessory type	Optional
Power output	100-240 V AC 50/60 Hz
Output Power output	max 700 mA CC

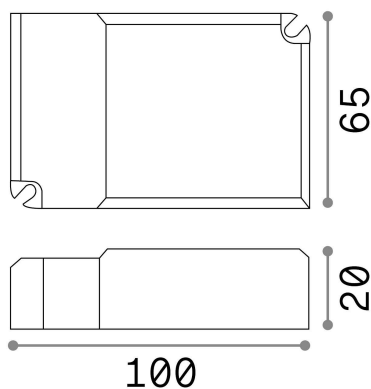

Source info

Max consumption	max 22 W
Standby power	< 0.50 W
Empty power	Not Applicable