

PHILIPS

Laven
9290033622
9290033623



User manual
Benutzerhandbuch
Notice d'emploi
Manual de usuario
Manual do usuário
Manuale d'uso
Gebruiksaanwijzing

Incl.

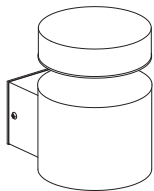

Excl.

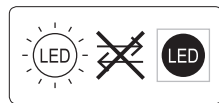
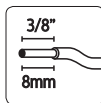
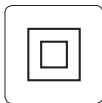
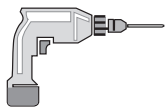

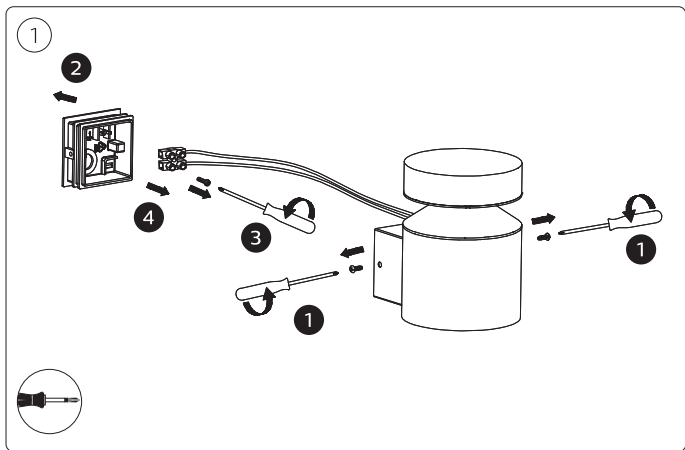
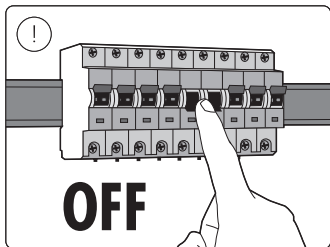

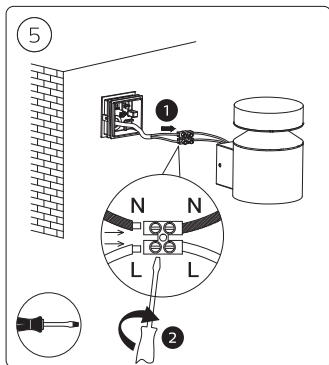
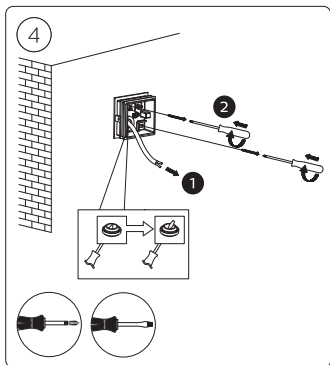
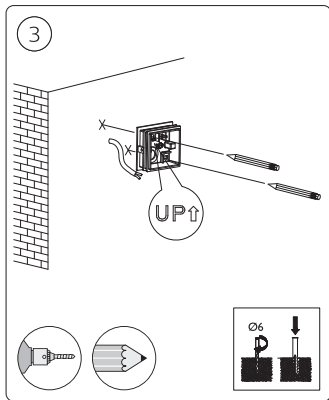
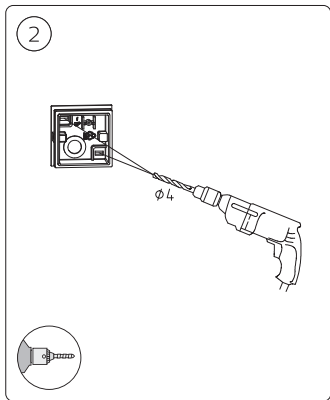

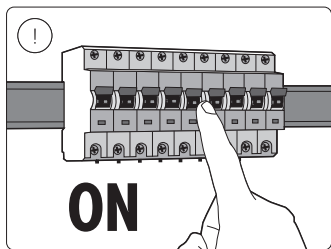
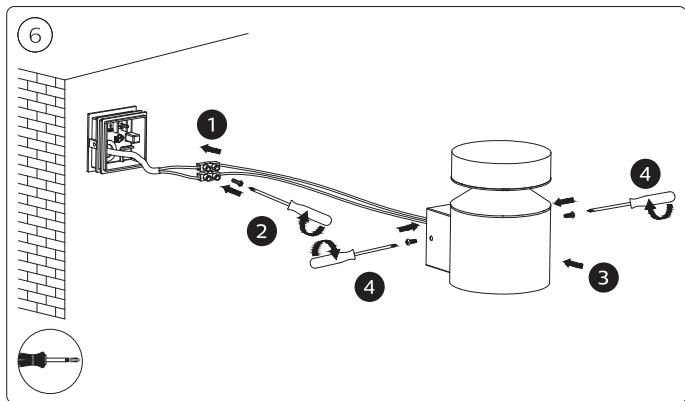



Signify Commercial UK Limited
Unit 3, Guildford Business Park,
Guildford, Surrey, GU2 8XG, UK

Signify
I.B.R.S. / C.C.R.I. Numéro 10461
5600 VB Eindhoven,
the Netherlands
☎00800-74454775

Philips and the Philips Shield Emblem are registered trademarks
of Koninklijke Philips N.V. and are used under license

3241 660 97171
www.philips.com/lighting

© 2023 Signify Holding

 **signify**