

PHILIPS

Camill Ultra Efficient
9290033638
9290033640



User manual
Benutzerhandbuch
Notice d'emploi
Manual de usuario
Manual do usuário
Manuale d'uso
Gebruiksaanwijzing

Incl.

A

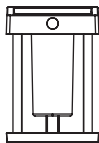

B



Excl.

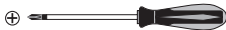
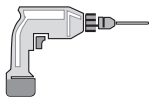

B



IP44

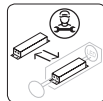
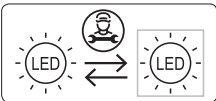
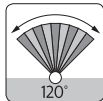
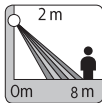
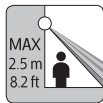

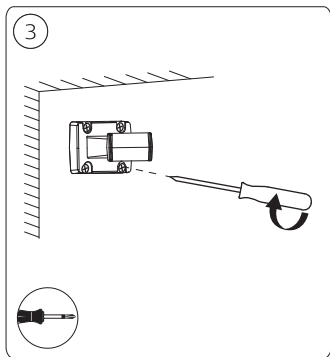
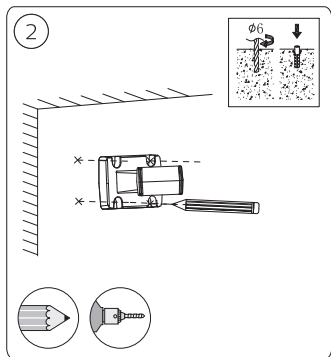
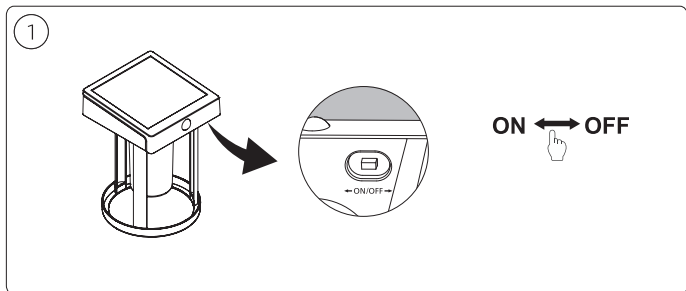

4

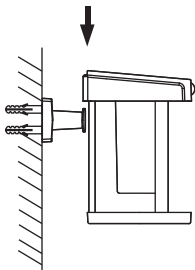

5

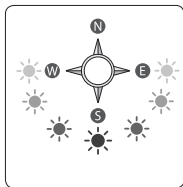
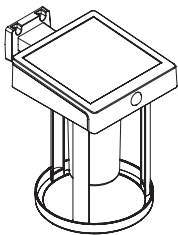

! Battery replacement

1

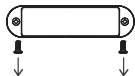
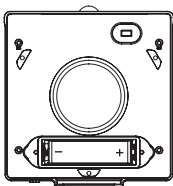

2

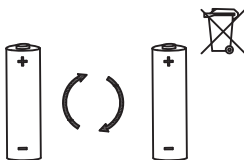

BUTTON-TOP WITH PROTECTION CIRCUIT
LI-ION 18650 3.7VBATTERY ONLY
MINIMUM BATTERY CAPACITY 2000mAh

3

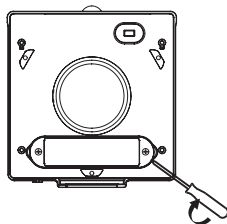



Signify Commercial UK Limited
Unit 3, Guildford Business Park,
Guildford, Surrey, GU2 8XG, UK

Signify
I.B.R.S. / C.C.R.I. Numéro 10461
5600 VB Eindhoven,
the Netherlands
☎00800-74454775

Philips and the Philips Shield Emblem
are registered trademarks of Koninklijke
Philips N.V. and are used under license.

www.philips.com/lighting

© 2023 Signify Holding
ignify

3241 661 00171